

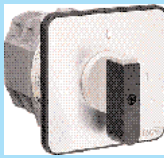









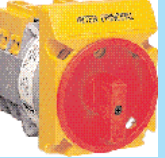

















Rotary Cam Switches
standard versions

PR40 series

IP40 standard IP65 on request

UL / CSA / CE

PR40											
UL508	50A general use - inductive load										
	1-phase	110/120Vac	3.0HP								
	3-phase	220/240Vac	15.0HP								
		440/480Vac	30.0HP								
		550/600Vac	30.0HP								
IEC 947-3	AC21 - 50A resistive load AC20 - 63A continuous			EQ72MN panel mount two screw medium gray/black handle 72mm square legend	BCFQ72MN standard size enclosure medium gray/black handle 72mm square legend	EJ723MND61 panel mount two screw yellow/red handle padlockable legend plate	EJ723MND61 panel mount two screw yellow/red handle padlockable legend plate				
Diagram	Positions	Function	Contacts	Part Number	Price	Part Number	Price	Part Number	Price	Part Number	Price
On/Off switch											
	1101 A4	1 pole		1	HB01AQ7	\$51.96	HB01AAQ	\$114.71			
	1102 A4	2 poles		2	HB02AQ7	\$62.32	HB02AAQ	\$125.08			
	1103 A4	3 poles		3	HB03AQ7	\$80.12	HB03ABQ	\$145.52			
	1104 A4	4 poles		4	HB04AQ7	\$90.37	HB04ABQ	\$153.12			
Main Switch											
	1103 GN	3 pole + gnd		3				HS3EV733	\$105.06	HS3EV733-IP65	\$109.65
	1104 GN	3 pole + late break neutral		4				HS4EV733	\$108.44	HS4EV733-IP65	\$113.03
Change-Over Switch with "OFF"											
	2201 C8	1 pole		2	HC01GQ7	\$62.32	HC01GAQ	\$125.08			
	2202 C8	2 poles		4	HC02GQ7	\$90.37	HC02GBQ	\$153.12			
	2203 C8	3 poles		6	HC03GQ7	\$113.13	HC03GCQ	\$184.67			
	2204 C8	4 poles		8	HC04GQ7	\$139.82	HC04GDQ	\$214.13			
Change-Over Switch without "OFF"											
	2251 D4	1 pole		2	HC51DQ7	\$62.32	HC51DAQ	\$125.08			
	2252 D4	2 poles		4	HC52DQ7	\$90.37	HC52DBQ	\$153.12			
	2253 D4	3 poles		6	HC53DQ7	\$113.13	HC53DCQ	\$184.67			
	2254 D4	4 poles		8	HC54DQ7	\$139.82	HC54DDQ	\$214.13			
3-Way Selector Switch with "OFF"											
	2301 A4	1 pole		3	HD01AQ7	\$80.12	HD01ABQ	\$145.52			
	2302 A4	2 poles		6	HD02AQ7	\$113.13	HD02ACQ	\$184.67			
	2303 A4	3 poles		9	HD03AQ7	\$158.51					
3-Phase Motor Switches											
	9151 C8		forward/reverse 1 speed	5	HZ11GQ7	\$103.01	HZ11GCQ	\$174.54			
	9153 C8		wye/delta starter for./rev., 1 speed	10	HZ13GQ7	\$168.80					
	9551 B4		wye/delta starter 1 direction, 1 spd.	8	HZ51BQ7	\$139.82	HZ51BDQ	\$214.13			
	9552 B4		Dahlander starter 1 direction, 2 spd.	8	HZ52BQ7	\$139.82	HZ52BDQ	\$214.13			
	9552 C4		Dahlander starter 1 direction, 2 spd.	8	HZ52CQ7	\$139.82	HZ52CDQ	\$214.13			

			Contacts	L ₁ /L ₃	L ₂
			1-2	2.36"	4.21"
			3-4	3.15"	4.21"
			5-6	3.94"	5.71"
			7-8	4.72"	5.71"
			9-10	5.51"	n/a