

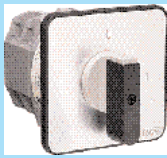









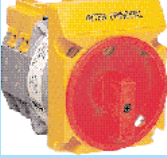
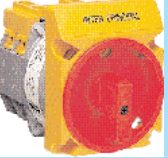













Rotary Cam Switches
standard versions

PR63 series

IP40 standard IP65 on request

UL / CSA / CE

PR63											
UL508	63A general use - inductive load										
	1-phase	110/120Vac	5.0HP								
	3-phase	220/240Vac	20.0HP								
		440/480Vac	40.0HP								
		550/600Vac	40.0HP								
IEC 947-3	AC21 - 80A resistive load AC20 - 80A continuous			EQ72MN panel mount two screw medium gray/black handle 72mm square legend	BCFQ72MN standard size enclosure medium gray/black handle 72mm square legend	EJ723MND61 panel mount two screw yellow/red handle padlockable legend plate	EJ723MND61 panel mount two screw yellow/red handle padlockable legend plate				
Diagram	Positions	Function	Contacts	Part Number	Price	Part Number	Price	Part Number	Price	Part Number	Price
On/Off switch											
1101 A4		1 pole	1	IB01AQ7	\$54.59	IB01AAQ	\$117.34				
1102 A4		2 poles	2	IB02AQ7	\$69.28	IB02AAQ	\$132.05				
1103 A4		3 poles	3	IB03AQ7	\$89.73	IB03ABQ	\$155.13				
1104 A4		4 poles	4	IB04AQ7	\$104.23	IB04ABQ	\$169.63				
Main Switch											
1103 GN		3 pole + gnd	3					IS3EV733	\$117.51	IS3EV733-IP65	\$122.10
1104 GN		3 pole + late break neutral	4					IS4EV733	\$122.30	IS4EV733-IP65	\$126.89
Change-Over Switch with "OFF"											
2201 C8		1 pole	2	IC01GQ7	\$69.28	IC01GAQ	\$132.05				
2202 C8		2 poles	4	IC02GQ7	\$104.23	IC02GBQ	\$169.63				
2203 C8		3 poles	6	IC03GQ7	\$134.63	IC03GCQ	\$206.17				
2204 C8		4 poles	8	IC04GQ7	\$161.88	IC04GDQ	\$244.94				
Change-Over Switch without "OFF"											
2251 D4		1 pole	2	IC51DQ7	\$69.28	IC51DAQ	\$132.05				
2252 D4		2 poles	4	IC52DQ7	\$104.23	IC52DBQ	\$169.63				
2253 D4		3 poles	6	IC53DQ7	\$134.63	IC53DCQ	\$206.17				
2254 D4		4 poles	8	IC54DQ7	\$161.88	IC54DDQ	\$244.94				
3-Way Selector Switch with "OFF"											
2301 A4		1 pole	3	ID01AQ7	\$89.73	ID01ABQ	\$155.13				
2302 A4		2 poles	6	ID02AQ7	\$134.63	ID02ACQ	\$206.17				
2303 A4		3 poles	9	ID03AQ7	\$182.80						
3-Phase Motor Switches											
9151 C8		forward/reverse 1 speed	5	IZ11GQ7	\$120.10	IZ11GCQ	\$191.63				
9153 C8		wye/delta starter for./rev., 1 speed	10	IZ13GQ7	\$197.26						
9551 B4		wye/delta starter 1 direction, 1 spd.	8	IZ51BQ7	\$170.62	IZ51BDQ	\$244.94				
9552 B4		Dahlander starter 1 direction, 2 spd.	8	IZ52BQ7	\$170.62	IZ52BDQ	\$244.94				
9552 C4		Dahlander starter 1 direction, 2 spd.	8	IZ52CQ7	\$170.62	IZ52CDQ	\$244.94				

			Contacts	L ₁ /L ₃	L ₂
			1-2	2.36"	4.21"
			3-4	3.15"	4.21"
			5-6	3.94"	5.71"
			7-8	4.72"	5.71"
			9-10	5.51"	n/a