

Concept

Our Rotary Cam Switches offer an economical and compact means of opening and closing electrical circuits. Numerous options allow us to create a switch to your specific requirements from a minimal number of basic components.

Design

The contacts of the switch are opened and closed by round disks called "cams". The cams are notched to allow the contacts to open and close in the positions you desire. A spring forces the contact closed wherever the cam is notched. The cam holds the contact open wherever it is not notched. Each contact is operated by its own cam, independent of the other cams in the switch. The contacts and cams are mounted in decks, each deck holding up to two contacts. The decks are stacked onto each other until the number of contacts you require is reached, with a maximum of 24 contacts. The switches are securely held together with two metal rods (the PR12 series is ultra-sonically welded together instead of using the metal rods). A chamber at the top of the switch holds a special cam which determines the switching angle or detent of the switch. Switches are available with 30, 45, 60 or 90 degree switching angles. The handle is attached to a shaft which goes through the switch and rotates the cams as the handle is turned, thus opening and closing the contacts as you desire.

Flexibility

- 1 to 24 contacts
- 8 switch sizes
- numerous mounting options
- a large selection of handles and accessories

Full Line Cam Switch Catalog

The material shown in this catalog is intended as a brief introduction to our line of Rotary Cam Switches. For further details on our rotary cam switches please request our full line cam switch catalog.

Rotary Cam Switches	Page
How To Order	7-145
PR12 standard switches	7-146 to 7-148
PR17 standard switches	7-149
PR21 standard switches	7-150
PR26 standard switches	7-151
PR40 standard switches	7-152
PR63 standard switches	7-153
PR125/160 standard switches	7-154
Technical specifications	7-155

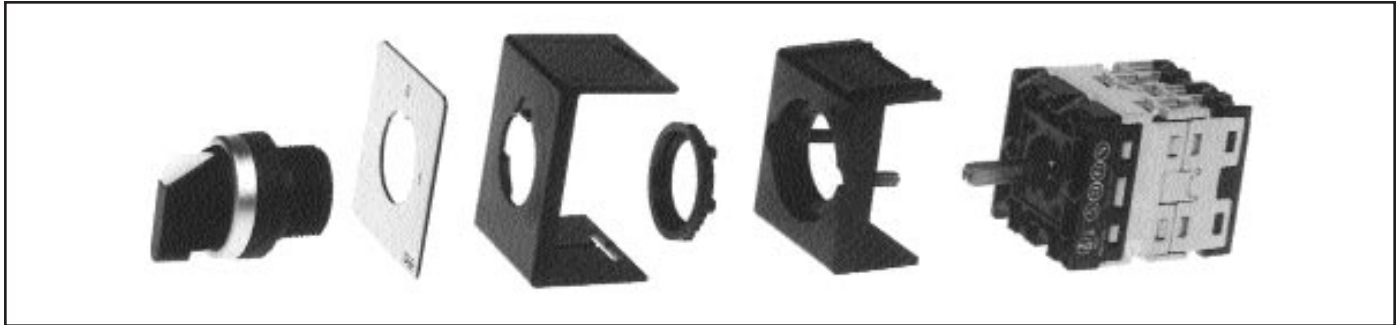

Part Numbers

Complete cam switch part numbers are developed sequentially, starting with the switch series and adding the reference numbers for the various features of the switch. These features are grouped in the following categories:

Category	Example Part Number
1) Switch series (electrical ratings)	PR12
2) Switch function (switching configuration)	1102
3) Switching angle (detent)	A4
4) Type of mounting	E
5) Type of legend / nameplate	Q48
6) Type of handle	PND

In the example above, the complete part number of the cam switch would be 'PR121102A4EQ48PND'.

When all of the features of the switch have been selected, the part number is complete. The complete part numbers can sometimes become too long to be entered into computer systems. To accommodate this, a unique condensed part number is assigned to every cam switch ordered. The part numbers for the 'standard cam switches' on the following pages represent the condensed part numbers. You may order using either expanded or condensed part numbers.

Assistance in Ordering

Due to their unique flexibility, ordering a rotary cam switch can be quite challenging. Our rotary cam switches are offered in eight different electrical ratings, from 1 to 24 contacts, with numerous mounting, legend plate, and handle options.

We invite you to contact our technical department for assistance in selecting the rotary cam switch which will best meet your needs. In order that we can more promptly provide you with the part number of the specific switch you require, if possible, please be prepared to answer the following questions regarding your application when you contact us:

- in general, what do you want the switch to do?
- can you provide a chart showing the opening/closing of the contacts ('X' chart)?
- what is the maximum current rating, make/break and continuous?
- what is the maximum voltage, ac or dc?
- how do you want to mount the switch?
- what type of legend plate and handle do you prefer?
- are there any special environmental conditions where the switch will be located?

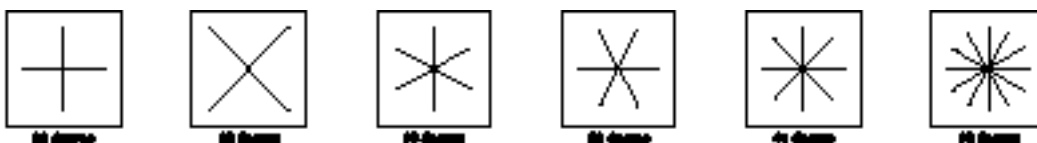











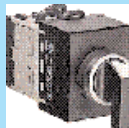
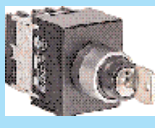



















Rotary Cam Switches
standard versions

PR12 series

IP40 standard IP65 on request

UL / CSA / CE











































PR12											
UL508	12A general use - inductive load			EN48MD50	EC21RA03	EC21RB03	EC21RC00				
	1-phase	110/120Vac	0.5HP								
	3-phase	220/240Vac	3.0HP								
		440/480Vac	5.0HP								
		550/600Vac	3.0HP								
IEC 947-3	AC21 - 16A resistive load AC20 - 20A continuous			22mm single hole mount small gray/black handle 48mm square legend	22mm single hole mount small black knob handle no legend plate	22mm single hole mount small black lever handle no legend plate	22mm single hole mount key lock switch no legend plate				
Diagram	Positions	Function	Contacts	Part Number	Price	Part Number	Price	Part Number	Price	Part Number	Price
On/Off switch											
1101 A4		1 pole	1	NB01AX80	\$24.44	NB01AC113	\$22.26	NB01AC123	\$23.41	NB01AC1C1	\$37.03
1102 A4		2 poles	2	NB02AX80	\$27.99	NB02AC113	\$25.80	NB02AC123	\$26.96	NB02AC1C1	\$40.58
1103 A4		3 poles	3	NB03AX80	\$31.13	NB03AC113	\$28.94	NB03AC123	\$30.10	NB03AC1C1	\$43.71
1104 A4		4 poles	4	NB04AX80	\$34.23	NB04AC113	\$32.04	NB04AC123	\$33.20	NB04AC1C1	\$46.81
Main Switch											
1103 GN		3 pole + gnd	3								
1104 GN		3 pole + late break neutral	4								
Change-Over Switch with "OFF"											
2201 C8		1 pole	2	NC01GX80	\$27.99	NC01GC113	\$25.80	NC01GC123	\$26.96	NC01GC1C1	\$40.58
2202 C8		2 poles	4	NC02GX80	\$34.23	NC02GC113	\$32.04	NC02GC123	\$33.20	NC02GC1C1	\$46.81
2203 C8		3 poles	6	NC03GX80	\$41.75	NC03GC113	\$39.56	NC03GC123	\$40.72	NC03GC1C1	\$54.34
2204 C8		4 poles	8	NC04GX80	\$48.66	NC04GC113	\$46.48	NC04GC123	\$47.63	NC04GC1C1	\$61.25
Change-Over Switch without "OFF"											
2251 D4		1 pole	2	NC51DX80	\$27.99	NC51DC113	\$25.80	NC51DC123	\$26.96		
2252 D4		2 poles	4	NC52DX80	\$34.23	NC52DC113	\$32.04	NC52DC123	\$33.20		
2253 D4		3 poles	6	NC53DX80	\$41.75	NC53DC113	\$39.56	NC53DC123	\$40.72		
2254 D4		4 poles	8	NC54DX80	\$48.66	NC54DC113	\$46.48	NC54DC123	\$47.63		
3-Way Selector Switch with "OFF"											
2301 A4		1 pole	3	ND01AX80	\$31.13	ND01AC113	\$28.94	ND01AC123	\$30.10	ND01AC1C1	\$43.71
2302 A4		2 poles	6	ND02AX80	\$41.75	ND02AC113	\$39.56	ND02AC123	\$40.72	ND02AC1C1	\$54.34
2303 A4		3 poles	9	ND03AX80	\$56.54	ND03AC113	\$54.36	ND03AC123	\$55.52	ND03AC1C1	\$69.14
3-Phase Motor Switches											
9151 C8		Forward/reverse 1 speed	5	NZ11GX80	\$39.77	NZ11GC113	\$37.59	NZ11GC123	\$38.74	NZ11GC1C1	\$52.36
9153 C8		Wye/delta starter for./rev., 1 speed	10	NZ13GX80	\$58.78	NZ13GC113	\$56.60	NZ13GC123	\$57.75	NZ13GC1C1	\$71.38
9551 B4		Wye/delta starter 1 direction, 1 spd.	8	NZ51GX80	\$48.66	NZ51GC113	\$46.48	NZ51GC123	\$47.63	NZ51GC1C1	\$61.25
9552 B4		Dahlander starter 1 direction, 2 spd.	8	NZ52GX80	\$48.66	NZ52GC113	\$46.48	NZ52GC123	\$47.63	NZ52GC1C1	\$61.25
9552 C4		Dahlander starter 1 direction, 2 spd.	8	NZ52CX80	\$48.66	NZ52CC113	\$46.48	NZ52CC123	\$47.63	NZ52CC1C1	\$61.25
Ammeter Switch - 3 phase											
8151 A4		3 current xfmrs with common point	6	NY11AX80	\$41.75	NY11AC113	\$39.56	NY11AC123	\$40.72	NY11AC1C1	\$54.34
8164 A4		Without current transformers	9	NY14AX80	\$56.54	NY14AC113	\$54.36	NY14AC123	\$55.52	NY14AC1C1	\$69.14
8157 A4		3 current xfmrs without common pt.	9	NY17AX80	\$56.54	NY17AC113	\$54.36	NY17AC123	\$55.52	NY17AC1C1	\$69.14
Voltmeter Switch - 3 phase											
8351 A4		Without neutral	4	NY31AX80	\$34.23	NY31AC113	\$32.04	NY31AC123	\$33.20	NY31AC1C1	\$46.81
8357 C8		With neutral	6	NY37GX80	\$41.75	NY37GC113	\$39.56	NY37GC123	\$40.72	NY37GC1C1	\$54.34





Rotary Cam Switches
standard versions

PR12 series

IP40 standard IP65 on request







UL / CSA / CE

PR12											
UL508	12A general use - inductive load										
	1-phase	110/120Vac	0.5HP								
	3-phase	220/240Vac	3.0HP								
		440/480Vac	5.0HP								
		550/600Vac	3.0HP								
IEC 947-3	AC21 - 16A resistive load AC20 - 20A continuous			EQ48PN panel mount two screw small gray/black handle 48mm square legend	BPRQ48PN reduced size enclosure small gray/black handle 48mm square legend	BCQ3 standard size enclosure small black handle 64mm square legend	EJ483PND51 panel mount two screw yellow/red handle padlockable legend plate				
Diagram	Positions	Function	Contacts	Part Number	Price	Part Number	Price	Part Number	Price	Part Number	Price
On/Off switch											
1101 A4		1 pole		1	NB01AQ1	\$18.81	NB01AGQ	\$32.09	NB01AXQ	\$43.54	
1102 A4		2 poles		2	NB02AQ1	\$22.36	NB02AGQ	\$35.64	NB02AXQ	\$47.09	
1103 A4		3 poles		3	NB03AQ1	\$25.50	NB03AHQ	\$39.58	NB03AXQ	\$50.23	
1104 A4		4 poles		4	NB04AQ1	\$28.60	NB04AHQ	\$42.68	NB04AXQ	\$53.33	
Main Switch											
1103 GN		3 pole + gnd		3						NS3EV493	\$35.18
1104 GN		3 pole + late break neutral		4						NS4EV493	\$36.21
Change-Over Switch with "OFF"											
2201 C8		1 pole		2	NC01GQ1	\$22.36	NC01GCQ	\$35.64	NC01GXQ	\$47.09	
2202 C8		2 poles		4	NC02GQ1	\$28.60	NC02GHQ	\$42.68	NC02GXQ	\$53.33	
2203 C8		3 poles		6	NC03GQ1	\$36.12			NC03GXQ	\$60.85	
2204 C8		4 poles		8	NC04GQ1	\$43.04			NC04GXQ	\$79.06	
Change-Over Switch without "OFF"											
2251 D4		1 pole		2	NC51DQ1	\$22.36	NC51DGQ	\$35.64	NC51DXQ	\$47.10	
2252 D4		2 poles		4	NC52DQ1	\$28.60	NC52DHQ	\$42.68	NC52DXQ	\$53.33	
2253 D4		3 poles		6	NC53DQ1	\$36.12			NC53DXQ	\$60.85	
2254 D4		4 poles		8	NC54DQ1	\$43.04			NC54DXQ	\$79.06	
3-Way Selector Switch with "OFF"											
2301 A4		1 pole		3	ND01AQ1	\$25.50	ND01AHQ	\$39.58	ND01AXQ	\$50.23	
2302 A4		2 poles		6	ND02AQ1	\$36.12			ND02AXQ	\$60.85	
2303 A4		3 poles		9	ND03AQ1	\$50.92			ND03AXQ	\$86.94	
3-Phase Motor Switches											
9151 C8		forward/reverse 1 speed	5		NZ11GQ1	\$34.14			NZ11GXQ	\$58.87	
9153 C8		wye/delta starter for./rev., 1 speed	10		NZ13GQ1	\$53.15			NZ13GXQ	\$89.18	
9551 B4		wye/delta starter 1 direction, 1 spd.	8		NZ51BQ1	\$43.04			NZ51BXQ	\$79.06	
9552 B4		Dahlander starter 1 direction, 2 spd.	8		NZ52BQ1	\$43.04			NZ52BXQ	\$79.06	
9552 C4		Dahlander starter 1 direction, 2 spd.	8		NZ52CQ1	\$43.04			NZ52CXQ	\$79.06	

					Contacts	L ₁ /L ₅	L ₂	L ₃	L ₄
					1-2	1.42"	2.01"	1.81"	3.03"
					3-4	1.81"	2.40"	2.28"	3.03"
					5-6	2.20"	2.80"	n/a	3.03"
					7-8	2.60"	3.19"	n/a	3.98"
					9-10	2.99"	3.58"	n/a	3.98"

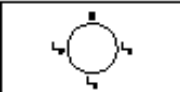
Rotary Cam Switches
standard versions

PR12 series

PR12 UL508 12A general use - inductive load 1-phase 110/120Vac 0.5HP 3-phase 220/240Vac 3.0HP 440/480Vac 5.0HP 550/600Vac 3.0HP IEC 947-3 AC21 - 16A resistive load AC20 - 20A continuous					PR12 cam switch for In-Panel mounting. Switch mounts to 35mm Din-Rail. Other standard and custom contact diagrams available. 6 contacts maximum.	
Diagram	Function	Contacts	Legend Plate	Part Number	List Price	
8351 A4	Voltmeter 3-phase without neutral	4		NDF01	\$47.15	
8151 A4	Ammeter 3-phase 3 current transformers with common point	6		NDF02	\$54.38	
8357 C8	Voltmeter 3-phase with neutral	6		NDF03	\$54.38	
2202 CR12	2-pole 2-way change-over switch with off spring return to off	4		NDF05	\$47.15	
2401 B8	1-pole 4-way selector switch with off	4		NDF06	\$47.15	
2202 C8	2-pole 2-way change-over switch with off	4		NDF15	\$47.15	

22mm single hole mounting operator heads

*For other collar options see page 3-58

Handle		
Color	Reference	List Price
Red	C21RA01	\$9.12
Green	C21RA02	
Black	C21RA03	
Gray	C21RA08	

Lever Handle		
Color	Reference	List Price
Red	C21RB01	\$10.28
Green	C21RB02	
Black	C21RB03	
Gray	C21RB08	

Key Lock 45°/90° Switching Angle		
Reference	Key Removable in Positions	List Price
C21RC00	1,3,5,7	\$23.89
C21RD00	3,7	
C21RE00	1,5	
C21RF00	2,4,6,8	
C21RG00	2,8	
C21RH00	4,8	

Key Lock 30°/60° Switching Angle		
Reference	Key Removable in Positions	List Price
C21RJ00	1,3,5,7,9,11	\$23.89
C21RK00	1,7	
C21RQ00	3,9	
C21RR00	5,11	
C21RL00	2,4,6,8,10,12	
C21RM00	4,10	
C21RS00	2,8	
C21RT00	6,12	

Rotary Cam Switches

standard versions

PR17 series

IP40 standard IP65 on request

UL / CSA / CE

PR17				EQ48PN		BCQ3		EJ483PND51		EJ483PND51	
UL508	16A general use - inductive load			panel mount two screw small gray/black handle 48mm square legend		standard size enclosure small black handle 64mm square legend		panel mount two screw yellow/red handle padlockable legend plate		panel mount two screw yellow/red handle padlockable legend plate	
	1-phase	110/120Vac	1.0HP								
	3-phase	220/240Vac	5.0HP								
		440/480Vac	7.5HP								
		550/600Vac	10.0HP								
IEC 947-3	AC21 - 20A resistive load AC20 - 25A continuous										
Diagram	Positions	Function	Contacts	Part Number	Price	Part Number	Price	Part Number	Price	Part Number	Price
On/Off switch											
1101 A4		1 pole	1	SB01AQ1	\$23.82	SB01AXQ	\$48.55				
1102 A4		2 poles	2	SB02AQ1	\$28.09	SB02AGQ	\$52.82				
1103 A4		3 poles	3	SB03AQ1	\$33.50	SB03AXQ	\$58.24				
1104 A4		4 poles	4	SB04AQ1	\$37.43	SB04AXQ	\$62.17				
Main Switch											
1103 GN		3 pole + gnd	3					SS3EV493	\$43.74	SS3EV493-IP65	\$48.33
1104 GN		3 pole + late break neutral	4					SS4EV493	\$45.04	SS4EV493-IP65	\$49.63
Change-Over Switch with "OFF"											
2201 C8		1 pole	2	SC01GQ1	\$28.09	SC01GXQ	\$52.82				
2202 C8		2 poles	4	SC02GQ1	\$37.43	SC02GXQ	\$62.17				
2203 C8		3 poles	6	SC03GQ1	\$46.48	SC03GXQ	\$71.21				
2204 C8		4 poles	8	SC04GQ1	\$55.96	SC04GXQ	\$91.99				
Change-Over Switch without "OFF"											
2251 D4		1 pole	2	SC51DQ1	\$28.09	SC51DXQ	\$52.82				
2252 D4		2 poles	4	SC52DQ1	\$37.43	SC52DXQ	\$62.17				
2253 D4		3 poles	6	SC53DQ1	\$46.48	SC53DXQ	\$71.21				
2254 D4		4 poles	8	SC54DQ1	\$55.96	SC54DXQ	\$91.99				
3-Way Selector Switch with "OFF"											
2301 A4		1 pole	3	SD01AQ1	\$33.50	SD01AXQ	\$58.24				
2302 A4		2 poles	6	SD02AQ1	\$71.21	SD02AXQ	\$71.21				
2303 A4		3 poles	9	SD03AQ1	\$61.88	SD03AXQ	\$97.71				
3-Phase Motor Switches											
9151 C8		forward/reverse 1 speed	5	SZ11GQ1	\$42.72	SZ11GXQ	\$67.45				
9153 C8		wye/delta starter for./rev., 1 speed	10	SZ13GQ1	\$65.55	SZ13GXQ	\$101.58				
9551 B4		wye/delta starter 1 direction, 1 spd.	8	SZ51BQ1	\$55.96	SZ51BXQ	\$91.99				
9552 B4		Dahlander starter 1 direction, 2 spd.	8	SZ52BQ1	\$55.96	SZ52BXQ	\$91.99				
9552 C4		Dahlander starter 1 direction, 2 spd.	8	SZ52CQ1	\$55.96	SZ52CXQ	\$91.99				

			Contacts	L ₁ /L ₃	L ₂
			1-2	1.30"	3.03"
			3-4	1.77"	3.03"
			5-6	2.24"	3.03"
			7-8	2.72"	3.98"
			9-10	3.19"	3.98"

Rotary Cam Switches

standard versions

PR21 series

IP40 standard IP65 on request

UL / CSA / CE

PR21											
UL508	20A general use - inductive load										
	1-phase	110/120Vac	1.5HP								
	3-phase	220/240Vac	5.0HP								
		440/480Vac	10.0HP								
		550/600Vac	15.0HP								
IEC 947-3	AC21 - 25A resistive load AC20 - 32A continuous			EQ48PN panel mount two screw small gray/black handle 48mm square legend	BCQ3 standard size enclosure small black handle 64mm square legend	EJ483PND51 panel mount two screw yellow/red handle padlockable legend plate	EJ483PND51 panel mount two screw yellow/red handle padlockable legend plate				
Diagram	Positions	Function	Contacts	Part Number	Price	Part Number	Price	Part Number	Price	Part Number	Price
On/Off switch											
	1101 A4	1 pole		TB01AQ1	\$26.17	TB01AXQ	\$50.90				
	1102 A4	2 poles		TB02AQ1	\$30.92	TB02AGQ	\$55.65				
	1103 A4	3 poles		TB03AQ1	\$37.19	TB03AXQ	\$61.93				
	1104 A4	4 poles		TB04AQ1	\$41.48	TB04AXQ	\$66.21				
Main Switch											
	1103 GN	3 pole + gnd						TS3EV493	\$47.67	TS3EV493-IP65	\$52.26
	1104 GN	3 pole + late break neutral						TS4EV493	\$49.09	TS4EV493-IP65	\$53.68
Change-Over Switch with "OFF"											
	2201 C8	1 pole		TC01GQ1	\$30.92	TC01GXQ	\$55.65				
	2202 C8	2 poles		TC02GQ1	\$41.48	TC02GXQ	\$66.21				
	2203 C8	3 poles		TC03GQ1	\$51.77	TC03GXQ	\$76.50				
	2204 C8	4 poles		TC04GQ1	\$62.64	TC04GXQ	\$98.66				
Change-Over Switch without "OFF"											
	2251 D4	1 pole		TC51DQ1	\$30.92	TC51DXQ	\$55.65				
	2252 D4	2 poles		TC52DQ1	\$41.48	TC52DXQ	\$66.21				
	2253 D4	3 poles		TC53DQ1	\$51.77	TC53DXQ	\$76.50				
	2254 D4	4 poles		TC54DQ1	\$62.64	TC54DXQ	\$98.66				
3-Way Selector Switch with "OFF"											
	2301 A4	1 pole		TD01AQ1	\$37.19	TD01AXQ	\$61.93				
	2302 A4	2 poles		TD02AQ1	\$51.77	TD02AXQ	\$76.50				
	2303 A4	3 poles		TD03AQ1	\$69.39	TD03AXQ	\$105.41				
3-Phase Motor Switches											
	9151 C8		forward/reverse 1 speed	5	TZ11GQ1	\$47.73	TZ11GXQ	\$72.46			
	9153 C8		wye/delta starter for./rev., 1 speed	10	TZ13GQ1	\$73.65	TZ13GXQ	\$109.68			
	9551 B4		wye/delta starter 1 direction, 1 spd.	8	TZ51BQ1	\$62.64	TZ51BXQ	\$98.66			
	9552 B4		Dahlander starter 1 direction, 2 spd.	8	TZ52BQ1	\$62.64	TZ52BXQ	\$98.66			
	9552 C4		Dahlander starter 1 direction, 2 spd.	8	TZ52CQ1	\$62.64	TZ52CXQ	\$98.66			











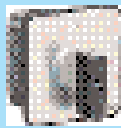













			Contacts	L ₁ /L ₃	L ₂
			1-2	1.30"	3.03"
			3-4	1.77"	3.03"
			5-6	2.24"	3.03"
			7-8	2.72"	3.98"
			9-10	3.19"	3.98"



Rotary Cam Switches
standard versions

PR26 series

IP40 standard IP65 on request

UL / CSA / CE

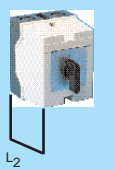
PR26				EQ72MN		BCQ3		EJ723MND51		EJ723MND51	
UL508 25A general use - inductive load 1-phase 110/120Vac 2.0HP 3-phase 220/240Vac 7.5HP 440/480Vac 15.0HP 550/600Vac 20.0HP											
IEC 947-3 AC21 - 32A resistive load AC20 - 40A continuous				panel mount two screw medium gray/black handle 72mm square legend		standard size enclosure small black handle 64mm square legend		panel mount two screw yellow/red handle padlockable legend plate		panel mount two screw yellow/red handle padlockable legend plate	
Diagram	Positions	Function	Contacts	Part Number	Price	Part Number	Price	Part Number	Price	Part Number	Price
On/Off switch											
1101 A4		1 pole	1	ZB01AQ7	\$32.97	ZB01AXQ	\$54.63				
1102 A4		2 poles	2	ZB02AQ7	\$40.25	ZB02AXQ	\$61.92				
1103 A4		3 poles	3	ZB03AQ7	\$50.07	ZB03AXQ	\$71.73				
1104 A4		4 poles	4	ZB04AQ7	\$56.52	ZB04AXQ	\$78.19				
Main Switch											
1103 GN		3 pole + gnd	3					ZS3EV733	\$68.70	ZS3EV733-IP65	\$73.29
1104 GN		3 pole + late break neutral	4					ZS4EV733	\$72.07	ZS4EV733-IP65	\$76.66
Change-Over Switch with "OFF"											
2201 C8		1 pole	2	ZC01GQ7	\$40.25	ZC01GXQ	\$61.92				
2202 C8		2 poles	4	ZC02GQ7	\$56.52	ZC02GXQ	\$78.19				
2203 C8		3 poles	6	ZC03GQ7	\$73.62	ZC03GXQ	\$106.58				
2204 C8		4 poles	8	ZC04GQ7	\$90.43	ZC04GXQ	\$123.39				
Change-Over Switch without "OFF"											
2251 D4		1 pole	2	ZC51DQ7	\$40.25	ZC51DXQ	\$61.92				
2252 D4		2 poles	4	ZC52DQ7	\$73.62	ZC52DXQ	\$78.19				
2253 D4		3 poles	6	ZC53DQ7	\$73.62	ZC53DXQ	\$106.58				
2254 D4		4 poles	8	ZC54DQ7	\$90.43	ZC54DXQ	\$123.39				
3-Way Selector Switch with "OFF"											
2301 A4		1 pole	3	ZD01AQ7	\$50.07	ZD01AXQ	\$71.73				
2302 A4		2 poles	6	ZD02AQ7	\$73.62	ZD02AXQ	\$106.58				
2303 A4		3 poles	9	ZD03AQ7	\$100.38						
3-Phase Motor Switches											
9151 C8		forward/reverse 1 speed	5	ZZ11GQ7	\$67.35	ZZ11GXQ	\$100.31				
9153 C8		wye/delta starter for./rev., 1 speed	10	ZZ13GQ7	\$106.84						
9551 B4		wye/delta starter 1 direction, 1 spd.	8	ZZ51BQ7	\$90.43	ZZ51BXQ	\$123.39				
9552 B4		Dahlander starter 1 direction, 2 spd.	8	ZZ52BQ7	\$90.43	ZZ52BXQ	\$123.39				
9552 C4		Dahlander starter 1 direction, 2 spd.	8	ZZ52CQ7	\$90.43	ZZ52CXQ	\$123.39				

			Contacts	L ₁ /L ₃	L ₂
			1-2	1.42"	3.03"
			3-4	2.01"	3.03"
			5-6	2.60"	3.98"
			7-8	3.19"	3.98"
			9-10	3.78"	n/a











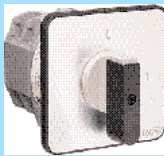















Rotary Cam Switches



standard versions

PR40 series

IP40 standard IP65 on request

UL / CSA / CE

PR40											
UL508	50A general use - inductive load										
	1-phase	110/120Vac	3.0HP								
	3-phase	220/240Vac	15.0HP								
		440/480Vac	30.0HP								
		550/600Vac	30.0HP								
IEC 947-3	AC21 - 50A resistive load AC20 - 63A continuous			EQ72MN panel mount two screw medium gray/black handle 72mm square legend	BCFQ72MN standard size enclosure medium gray/black handle 72mm square legend	EJ723MND61 panel mount two screw yellow/red handle padlockable legend plate	EJ723MND61 panel mount two screw yellow/red handle padlockable legend plate				
Diagram	Positions	Function	Contacts	Part Number	Price	Part Number	Price	Part Number	Price	Part Number	Price
On/Off switch											
	1101 A4	1 pole		1	HB01AQ7	\$51.96	HB01AAQ	\$114.71			
	1102 A4	2 poles		2	HB02AQ7	\$62.32	HB02AAQ	\$125.08			
	1103 A4	3 poles		3	HB03AQ7	\$80.12	HB03ABQ	\$145.52			
	1104 A4	4 poles		4	HB04AQ7	\$90.37	HB04ABQ	\$153.12			
Main Switch											
	1103 GN	3 pole + gnd		3				HS3EV733	\$105.06	HS3EV733-IP65	\$109.65
	1104 GN	3 pole + late break neutral		4				HS4EV733	\$108.44	HS4EV733-IP65	\$113.03
Change-Over Switch with "OFF"											
	2201 C8	1 pole		2	HC01GQ7	\$62.32	HC01GAQ	\$125.08			
	2202 C8	2 poles		4	HC02GQ7	\$90.37	HC02GBQ	\$153.12			
	2203 C8	3 poles		6	HC03GQ7	\$113.13	HC03GCQ	\$184.67			
	2204 C8	4 poles		8	HC04GQ7	\$139.82	HC04GDQ	\$214.13			
Change-Over Switch without "OFF"											
	2251 D4	1 pole		2	HC51DQ7	\$62.32	HC51DAQ	\$125.08			
	2252 D4	2 poles		4	HC52DQ7	\$90.37	HC52DBQ	\$153.12			
	2253 D4	3 poles		6	HC53DQ7	\$113.13	HC53DCQ	\$184.67			
	2254 D4	4 poles		8	HC54DQ7	\$139.82	HC54DDQ	\$214.13			
3-Way Selector Switch with "OFF"											
	2301 A4	1 pole		3	HD01AQ7	\$80.12	HD01ABQ	\$145.52			
	2302 A4	2 poles		6	HD02AQ7	\$113.13	HD02ACQ	\$184.67			
	2303 A4	3 poles		9	HD03AQ7	\$158.51					
3-Phase Motor Switches											
	9151 C8		forward/reverse 1 speed	5	HZ11GQ7	\$103.01	HZ11GCQ	\$174.54			
	9153 C8		wye/delta starter for./rev., 1 speed	10	HZ13GQ7	\$168.80					
	9551 B4		wye/delta starter 1 direction, 1 spd.	8	HZ51BQ7	\$139.82	HZ51BDQ	\$214.13			
	9552 B4		Dahlander starter 1 direction, 2 spd.	8	HZ52BQ7	\$139.82	HZ52BDQ	\$214.13			
	9552 C4		Dahlander starter 1 direction, 2 spd.	8	HZ52CQ7	\$139.82	HZ52CDQ	\$214.13			











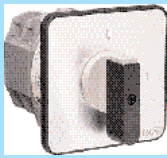

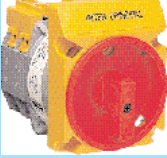
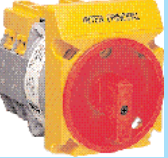









			Contacts	L ₁ /L ₃	L ₂
			1-2	2.36"	4.21"
			3-4	3.15"	4.21"
			5-6	3.94"	5.71"
			7-8	4.72"	5.71"
			9-10	5.51"	n/a



Rotary Cam Switches
standard versions

PR63 series

IP40 standard IP65 on request

UL / CSA / CE

PR63											
UL508	63A general use - inductive load										
	1-phase	110/120Vac	5.0HP								
	3-phase	220/240Vac	20.0HP								
		440/480Vac	40.0HP								
		550/600Vac	40.0HP								
IEC 947-3	AC21 - 80A resistive load AC20 - 80A continuous			EQ72MN panel mount two screw medium gray/black handle 72mm square legend	BCFQ72MN standard size enclosure medium gray/black handle 72mm square legend	EJ723MND61 panel mount two screw yellow/red handle padlockable legend plate	EJ723MND61 panel mount two screw yellow/red handle padlockable legend plate				
Diagram	Positions	Function	Contacts	Part Number	Price	Part Number	Price	Part Number	Price	Part Number	Price
On/Off switch											
1101 A4		1 pole	1	IB01AQ7	\$54.59	IB01AAQ	\$117.34				
1102 A4		2 poles	2	IB02AQ7	\$69.28	IB02AAQ	\$132.05				
1103 A4		3 poles	3	IB03AQ7	\$89.73	IB03ABQ	\$155.13				
1104 A4		4 poles	4	IB04AQ7	\$104.23	IB04ABQ	\$169.63				
Main Switch											
1103 GN		3 pole + gnd	3					IS3EV733	\$117.51	IS3EV733-IP65	\$122.10
1104 GN		3 pole + late break neutral	4					IS4EV733	\$122.30	IS4EV733-IP65	\$126.89
Change-Over Switch with "OFF"											
2201 C8		1 pole	2	IC01GQ7	\$69.28	IC01GAQ	\$132.05				
2202 C8		2 poles	4	IC02GQ7	\$104.23	IC02GBQ	\$169.63				
2203 C8		3 poles	6	IC03GQ7	\$134.63	IC03GCQ	\$206.17				
2204 C8		4 poles	8	IC04GQ7	\$161.88	IC04GDQ	\$244.94				
Change-Over Switch without "OFF"											
2251 D4		1 pole	2	IC51DQ7	\$69.28	IC51DAQ	\$132.05				
2252 D4		2 poles	4	IC52DQ7	\$104.23	IC52DBQ	\$169.63				
2253 D4		3 poles	6	IC53DQ7	\$134.63	IC53DCQ	\$206.17				
2254 D4		4 poles	8	IC54DQ7	\$161.88	IC54DDQ	\$244.94				
3-Way Selector Switch with "OFF"											
2301 A4		1 pole	3	ID01AQ7	\$89.73	ID01ABQ	\$155.13				
2302 A4		2 poles	6	ID02AQ7	\$134.63	ID02ACQ	\$206.17				
2303 A4		3 poles	9	ID03AQ7	\$182.80						
3-Phase Motor Switches											
9151 C8		forward/reverse 1 speed	5	IZ11GQ7	\$120.10	IZ11GCQ	\$191.63				
9153 C8		wye/delta starter for./rev., 1 speed	10	IZ13GQ7	\$197.26						
9551 B4		wye/delta starter 1 direction, 1 spd.	8	IZ51BQ7	\$170.62	IZ51BDQ	\$244.94				
9552 B4		Dahlander starter 1 direction, 2 spd.	8	IZ52BQ7	\$170.62	IZ52BDQ	\$244.94				
9552 C4		Dahlander starter 1 direction, 2 spd.	8	IZ52CQ7	\$170.62	IZ52CDQ	\$244.94				











































			Contacts	L ₁ /L ₃	L ₂
			1-2	2.36"	4.21"
			3-4	3.15"	4.21"
			5-6	3.94"	5.71"
			7-8	4.72"	5.71"
			9-10	5.51"	n/a

Rotary Cam Switches
standard versions

PR125 / PR160

IP40 standard IP65 on request

CE

PR125 IEC 947-3 AC21 - 160A resistive load AC20 - 200A continuous						PR160 IEC 947-3 AC21 - 200A resistive load AC20 - 250A continuous					
				EQ96GN panel mount two screw large gray/black handle 96mm square legend						EQ96GN panel mount two screw large gray/black handle 96mm square legend	
Diagram	Positions	Function	Contacts	Part Number	Price			Part Number	Price		
On/Off switch											
1101 A4		1 pole		1	LB01AQ9	\$100.62		MB01AQ9	\$121.11		
1102 A4		2 poles		2	LB02AQ9	\$150.23		MB02AQ9	\$186.23		
1103 A4		3 poles		3	LB03AQ9	\$211.10		MB03AQ9	\$264.11		
1104 A4		4 poles		4	LB04AQ9	\$242.34		MB04AQ9	\$326.73		
Change-Over Switch with "OFF"											
2201 C8		1 pole		2	LC01GQ9	\$150.23		MC01GQ9	\$186.01		
2202 C8		2 poles		4	LC02GQ9	\$242.34		MC02GQ9	\$326.73		
2203 C8		3 poles		6	LC03GQ9	\$346.20		MC03GQ9	\$478.74		
2204 C8		4 poles		8	LC04GQ9	\$449.64		MC04GQ9	\$612.58		
Change-Over Switch without "OFF"											
2251 D4		1 pole		2	LC51DQ9	\$150.23		MC51DQ9	\$186.01		
2252 D4		2 poles		4	LC52DQ9	\$242.34		MC52DQ9	\$326.73		
2253 D4		3 poles		6	LC53DQ9	\$346.20		MC53DQ9	\$478.74		
2254 D4		4 poles		8	LC54DQ9	\$449.64		MC54DQ9	\$612.58		
3-Way Selector Switch with "OFF"											
2301 A4		1 pole		3	LD01AQ9	\$211.32		MD01AQ9	\$264.11		
2302 A4		2 poles		6	LD02AQ9	\$346.20		MD02AQ9	\$478.74		
2303 A4		3 poles		9	LD03AQ9	\$510.15		MD03AQ9	\$695.96		
3-Phase Motor Switches											
9151 C8		forward/reverse 1 speed		5	LZ11GQ9	\$302.56		MZ11GQ9	\$409.96		
9153 C8		wye/delta starter for./rev., 1 speed		10	LZ13GQ9	\$553.68		MZ13GQ9	\$758.26		
9551 B4		wye/delta starter 1 direction, 1 spd.		8	LZ51BQ9	\$449.64		MZ51BQ9	\$612.58		
9552 B4		Dahlander starter 1 direction, 2 spd.		8	LZ52BQ9	\$449.64		MZ52BQ9	\$612.58		
9552 C4		Dahlander starter 1 direction, 2 spd.		8	LZ52CQ9	\$449.64		MZ52CQ9	\$612.58		

	Contacts	L ₁
	1-2	3.15"
	3-4	4.72"
	5-6	6.30"
	7-8	7.87"
	9-10	9.45"

	PR12	PR17	PR21	PR26	PR40	PR63	PR125	PR160
UL/CSA								
1 phase 110/120 Vac	0.5 hp	1 hp	1.5 hp	2 hp	3 hp	5 hp	n/a	n/a
3 phase 110/120 Vac	1 hp	2 hp	3 hp	3 hp	7.5 hp	10 hp	n/a	n/a
220/240 Vac	3 hp	5 hp	5 hp	7.5 hp	15 hp	20 hp	n/a	n/a
440/480 Vac	5 hp	7.5 hp	10 hp	15 hp	30 hp	40 hp	n/a	n/a
550/600 Vac	3 hp	10 hp	15 hp	20 hp	30 hp	40 hp	n/a	n/a
General Use (600 V) (Motor Controller)	12 A	16A	20 A	25 A	50 A	63 A	n/a	n/a
UL 508 Recognized	Yes	Yes	Yes	Yes	Yes	Yes	No	No
CSA Certified	Yes	Yes	Yes	Yes	Yes	Yes	No	No
IEC 947-3*								
AC 3 (3 x 400 Vac)	4 kW	7.5kW	7.5 kW	11 kW	18.5 kW	22 kW	n/a	n/a
AC 23 (3 x 400 Vac)	7.5 kW	11kW	11 kW	15 kW	22kW	25 kW	n/a	n/a
AC 21	16 A	20 A	25 A	32 A	50 A	80A	160A	200A
DC1 (24 Vdc)	16 A	20 A	25 A	32 A	50 A	80A	n/a	n/a
* AC 3	Squirrel cage motors: starting, switching off of motors during running							
AC 23	Switching of motor loads or other highly inductive loads							
AC 21	Switching of resistive loads including moderate overloads							
DC 1	Non-inductive or slightly inductive loads, resistance furnaces							
Maximum Wire Gauge								
Rigid mm ²	4	6 (4*)	6(4*)	6	16	16	8mm screw for eyelet	
AWG	10	8 (10*)	8 (10*)	8	6	6		
Flexible mm ²	2.5	4	4	6	16	16		
AWG	14	12	12	8	6	6		
*These values correspond to wiring carried out on terminals with jumpers.								
Mechanical Life	1,250,000 operations, 150 per hour maximum.							
Operating Temperature Limits	-4° F to 158° F (-20° C to 70° C)							

Mounting Options:

- 1) Front mounting, installed from rear of panel, secured by 2 screws at 30mm or 50mm interval.
- 2) Front mounting, installed from rear of panel, secured by 4 screws at 36/48/68mm square intervals.
- 3) Rear mounting, secured by 4 screws at 48/68mm square intervals.
- 4) Rear mounting onto 35mm Din-rail.
- 5) Front mounting in 22mm single hole with knob handle (PR12 only).
- 6) Front mounting in 22mm single hole with key handle (PR12 only).
- 7) Front mounting in 22mm single hole with legend plate and handle (PR12 only).
- 8) Front mounting in a 30mm hole, one-piece assembly, with handle

